

18" SLOPED SAFETY END
ALL MEASUREMENTS APPROX.

ISOMETRIC



Phone: (713)222 6216
2918 Elysian st. Houston TX 77009
info@concreteASAP.com
www.ConcreteASAP.com

18" SLOPED SAFETY END (MALE SECTION)

DRAWING BY:
MC/SRM Group EU

SCALE: ****	APPROVED BY:
DATE: JULY 2014	Production Manager

CONTENT: Isometric

DRAWING NUMBER: CASE0018-01	REV: N/A
-----------------------------	----------

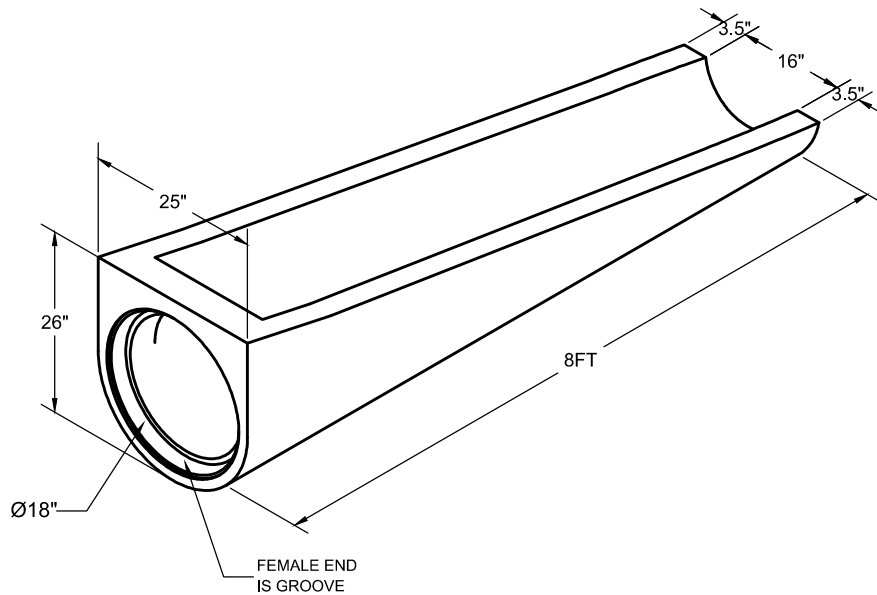

18" SLOPED SAFETY END
ALL MEASUREMENTS APPROX.

ISOMETRIC



Phone: (713)222 6216
2918 Elysian st. Houston TX 77009
info@concreteASAP.com
www.ConcreteASAP.com

18" SLOPED SAFETY END (FEMALE SECTION)

DRAWING BY:
MC/SRM Group EU

SCALE: ****	APPROVED BY:
DATE: JULY 2014	Production Manager

CONTENT: Isometric

DRAWING NUMBER: CASE0018-01	REV: N/A
-----------------------------	----------